

Date	Rev.	Project no.	Dwg-no. NSR_RWS
Drawn by	Rev.date		
Scale	Project	Filename NSR_RWS.dwg	

NORDIC RAINWATER SYSTEM

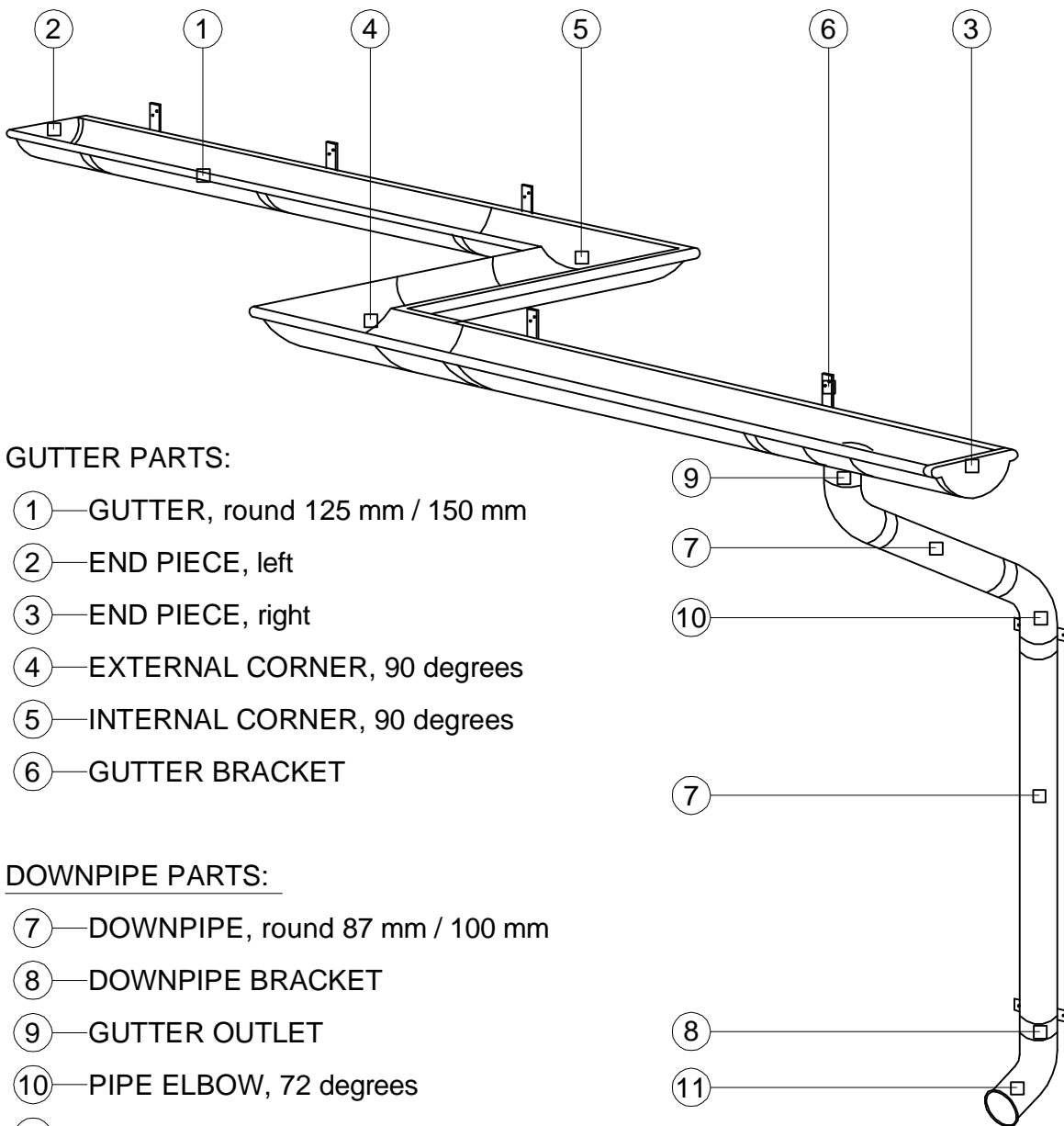

GUTTER PARTS:

- ① — GUTTER, round 125 mm / 150 mm
- ② — END PIECE, left
- ③ — END PIECE, right
- ④ — EXTERNAL CORNER, 90 degrees
- ⑤ — INTERNAL CORNER, 90 degrees
- ⑥ — GUTTER BRACKET

DOWNPIPE PARTS:

- ⑦ — DOWNPIPE, round 87 mm / 100 mm
- ⑧ — DOWNPIPE BRACKET
- ⑨ — GUTTER OUTLET
- ⑩ — PIPE ELBOW, 72 degrees
- ⑪ — OUTLET, 72 degrees

- ⑫ — FUNNEL, RECTANGULAR
- ⑫ — FUNNEL, ROUND

MATERIALS:

	NORDIC STANDARD
	NORDIC BROWN
	NORDIC GREEN

Date	Rev.	Project no.	Dwg-no. NSR_RWS
Drawn by	Rev.date		
Scale	Project	Filename NSR_RWS.dwg	

① — GUTTER



MATERIALS:

- NORDIC STANDARD
- NORDIC BROWN
- NORDIC GREEN

1. GUTTER, ROUND 125 mm

CODE	DIMENSIONS	LENGHT	WEIGHTkg/unit	
 RW DA 28006	d=125 mm, t=0,60 mm	2000	1,50 kg/m (3,00 kg/pc)	
 RW DAO 28006	d=125 mm, t=0,60 mm	2000	1,50 kg/m (3,00 kg/pc)	
 RW DAP 28006	d=125 mm, t=0,60 mm	2000	1,50 kg/m (3,00 kg/pc)	

2. GUTTER, ROUND 150 mm

CODE	DIMENSIONS	LENGHT	WEIGHTkg/unit	
 RW DA 33306	d=150 mm, t=0,60 mm	2000	1,79 kg/m (3,58 kg/pc)	
 RW DAO 33306	d=150 mm, t=0,60 mm	2000	1,79 kg/m (3,58 kg/pc)	
 RW DAP 33306	d=150 mm, t=0,60 mm	2000	1,79 kg/m (3,58 kg/pc)	



Subject



NSR RAINWATER SYSTEM PARTS

Date	Rev.	Project no.	Dwg-no. NSR_RWS
Drawn by	Rev.date		
Scale	Project	Filename NSR_RWS.dwg	



② — END PIECE, left





MATERIALS:

-  NORDIC STANDARD
-  NORDIC BROWN
-  NORDIC GREEN

1. END PIECE, left (gutter, round 125 mm)

CODE	DIMENSIONS	WEIGHTkg/unit
 RW ZRBDLL 280	d=125 mm, t=0,60 mm	0,12 kg/pc
 RW ZRBDLLO 280	d=125 mm, t=0,60 mm	0,12 kg/pc
 RW ZRBDLLP 280	d=125 mm, t=0,60 mm	0,12 kg/pc

2. END PIECE, left (gutter, round 150 mm)

CODE	DIMENSIONS	WEIGHTkg/unit
 RW ZRBDLL 333	d=150 mm, t=0,60 mm	0,15 kg/pc
 RW ZRBDLLO 333	d=150 mm, t=0,60 mm	0,15 kg/pc
 RW ZRBDLLP 333	d=150 mm, t=0,60 mm	0,15 kg/pc



Subject



NSR RAINWATER SYSTEM PARTS

Date	Rev.	Project no.	Dwg-no. NSR_RWS
Drawn by	Rev.date		
Scale	Project	Filename NSR_RWS.dwg	



③ — END PIECE, right





MATERIALS:

-  NORDIC STANDARD
-  NORDIC BROWN
-  NORDIC GREEN

1. END PIECE, right (gutter, round 125 mm)

CODE	DIMENSIONS	WEIGHTkg/unit
 RW ZRBDRL 280	d=125 mm, t=0,60 mm	0,12 kg/pc
 RW ZRBDRL 280	d=125 mm, t=0,60 mm	0,12 kg/pc
 RW ZRBDRLP 280	d=125 mm, t=0,60 mm	0,12 kg/pc

2. END PIECE, right (gutter, round 150 mm)

CODE	DIMENSIONS	WEIGHTkg/unit
 RW ZRBDRL 333	d=150 mm, t=0,60 mm	0,15 kg/pc
 RW ZRBDRL 333	d=150 mm, t=0,60 mm	0,15 kg/pc
 RW ZRBDRLP 333	d=150 mm, t=0,60 mm	0,15 kg/pc

Date	Rev.	Project no.	Dwg-no. NSR_RWS
Drawn by	Rev.date		
Scale	Project	Filename NSR_RWS.dwg	

④ — EXTERNAL CORNER



MATERIALS:

- NORDIC STANDARD
- NORDIC BROWN
- NORDIC GREEN

1. EXTERNAL CORNER (gutter, round 125 mm)

CODE	DIMENSIONS	WEIGHTkg/unit
 RW ZRWIAT 280	d=125 mm, t=0,60 mm	1,20 kg/pc
 RW ZRWIATO 280	d=125 mm, t=0,60 mm	1,20 kg/pc
 RW ZRWIATP 280	d=125 mm, t=0,60 mm	1,20 kg/pc

2. EXTERNAL CORNER (gutter, round 150 mm)

CODE	DIMENSIONS	WEIGHTkg/unit
 RW ZRWIAT 333	d=150 mm, t=0,60 mm	1,25 kg/pc
 RW ZRWIATO 333	d=150 mm, t=0,60 mm	1,25 kg/pc
 RW ZRWIATP 333	d=150 mm, t=0,60 mm	1,25 kg/pc

Date	Rev.	Project no.	Dwg-no. NSR_RWS
Drawn by	Rev.date		
Scale	Project	Filename NSR_RWS.dwg	

⑤ — INTERNAL CORNER



MATERIALS:

- NORDIC STANDARD
- NORDIC BROWN
- NORDIC GREEN

1. INTERNAL CORNER (gutter, round 125 mm)

CODE	DIMENSIONS	WEIGHTkg/unit
 RW ZRWIIT 280	d=125 mm, t=0,60 mm	1,20 kg/pc
 RW ZRWIITO 280	d=125 mm, t=0,60 mm	1,20 kg/pc
 RW ZRWIITP 280	d=125 mm, t=0,60 mm	1,20 kg/pc

2. INTERNAL CORNER (gutter, round 150 mm)

CODE	DIMENSIONS	WEIGHTkg/unit
 RW ZRWIIT 333	d=150 mm, t=0,60 mm	1,25 kg/pc
 RW ZRWIITO 333	d=150 mm, t=0,60 mm	1,25 kg/pc
 RW ZRWIITP 333	d=150 mm, t=0,60 mm	1,25 kg/pc



Subject



NSR RAINWATER SYSTEM PARTS

Date	Rev.	Project no.	Dwg-no. NSR_RWS
Drawn by	Rev.date		
Scale	Project	Filename NSR_RWS.dwg	



⑥ — GUTTER BRACKET





MATERIALS:

-  NORDIC STANDARD
-  NORDIC BROWN
-  NORDIC GREEN

1. GUTTER BRACKET (gutter, round 125 mm)

CODE	DIMENSIONS	WEIGHTkg/unit	
 RW ZRTRK 28304	d=125 mm, b=30 mm, t=4,0 mm	0,32 kg/pc	
 RW ZRTRKO 28304	d=125 mm, b=30 mm, t=4,0 mm	0,32 kg/pc	
 RW ZRTRKP 28004	d=125 mm, b=30 mm, t=4,0 mm	0,32 kg/pc	

2. GUTTER BRACKET (gutter, round 150 mm)

CODE	DIMENSIONS	WEIGHTkg/unit	
 RW ZRTRK 33305	d=150 mm, b=30 mm, t=5,0 mm	0,35 kg/pc	
 RW ZRTRKO 33305	d=150 mm, b=30 mm, t=5,0 mm	0,35 kg/pc	
 RW ZRTRKP 33305	d=150 mm, b=30 mm, t=5,0 mm	0,35 kg/pc	



Subject



NSR RAINWATER SYSTEM PARTS

Date	Rev.	Project no.	Dwg-no. NSR_RWS
Drawn by	Rev.date		
Scale	Project	Filename NSR_RWS.dwg	

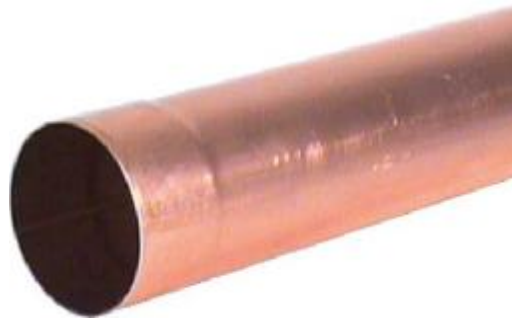

⑦ — DOWNPIPE



MATERIALS:

-  NORDIC STANDARD
-  NORDIC BROWN
-  NORDIC GREEN

1. DOWNPIPE, ROUND 87 mm

CODE	DIMENSIONS	LENGHT	WEIGHTkg/unit	
 RW ROS 08706	d=87 mm, t=0,60 mm	2000	1,55 kg/m (3,10 kg/pc)	
 RW ROFO 08706	d=87 mm, t=0,60 mm	2000	1,55 kg/m (3,10 kg/pc)	
 RW ROFP 08706	d=87 mm, t=0,60 mm	2000	1,55 kg/m (3,10 kg/pc)	

2. DOWNPIPE, ROUND 100 mm

CODE	DIMENSIONS	LENGHT	WEIGHTkg/unit	
 RW ROS 10006	d=100 mm, t=0,60 mm	2000	1,77 kg/m (3,54 kg/pc)	
 RW ROFO 10006	d=100 mm, t=0,60 mm	2000	1,77 kg/m (3,54 kg/pc)	
 RW ROFP 10006	d=100 mm, t=0,60 mm	2000	1,77 kg/m (3,54 kg/pc)	



Subject



NSR RAINWATER SYSTEM PARTS

Date	Rev.	Project no.	Dwg-no. NSR_RWS
Drawn by	Rev.date		
Scale	Project	Filename NSR_RWS.dwg	



⑦ — DOWNPIPE





MATERIALS:

-  NORDIC STANDARD
-  NORDIC BROWN
-  NORDIC GREEN

1. DOWNPIPE, ROUND 87 mm

CODE	DIMENSIONS	LENGHT	WEIGHTkg/unit	
 RW ROS 08706	d=87 mm, t=0,60 mm	1000	1,55 kg/m (1,55 kg/pc)	
 RW ROFO 08706	d=87 mm, t=0,60 mm	1000	1,55 kg/m (1,55 kg/pc)	
 RW ROFP 08706	d=87 mm, t=0,60 mm	1000	1,55 kg/m (1,55 kg/pc)	

2. DOWNPIPE, ROUND 100 mm

CODE	DIMENSIONS	LENGHT	WEIGHTkg/unit	
 RW ROS 10006	d=100 mm, t=0,60 mm	1000	1,77 kg/m (1,77 kg/pc)	
 RW ROFO 10006	d=100 mm, t=0,60 mm	1000	1,77 kg/m (1,77 kg/pc)	
 RW ROFP 10006	d=100 mm, t=0,60 mm	1000	1,77 kg/m (1,77 kg/pc)	

Date	Rev.	Project no.	Dwg-no. NSR_RWS
Drawn by	Rev.date		
Scale	Project	Filename NSR_RWS.dwg	

⑧ — DOWNPIPE BRACKET



MATERIALS:

- NORDIC STANDARD
- NORDIC BROWN
- NORDIC GREEN

1. DOWNPIPE BRACKET (downpipe, round 87 mm)

CODE	DIMENSIONS	WEIGHTkg/unit
 RW ZRSK 087	d=87 mm	0,15 kg/pc
 RW ZRSKO 087	d=87 mm	0,15 kg/pc
 RW ZRSKP 087	d=87 mm	0,15 kg/pc

2. DOWNPIPE BRACKET (downpipe, round 100 mm)

CODE	DIMENSIONS	WEIGHTkg/unit
 RW ZRSK 100	d=100 mm	0,20 kg/pc
 RW ZRSKO 100	d=100 mm	0,20 kg/pc
 RW ZRSKP 100	d=100 mm	0,20 kg/pc



Subject



NSR RAINWATER SYSTEM PARTS

Date	Rev.	Project no.	Dwg-no. NSR_RWS
Drawn by	Rev.date		
Scale	Project	Filename NSR_RWS.dwg	



⑨ — GUTTER OUTLET





MATERIALS:

-  NORDIC STANDARD
-  NORDIC BROWN
-  NORDIC GREEN

1. GUTTER OUTLET (gutter, round 100 mm, downpipe, round 87 mm)

CODE	DIMENSIONS	WEIGHTkg/unit
 RW ZSTDST 280087		0,55 kg/pc
 RW ZSTDO 280087		0,55 kg/pc
 RW ZSTDP 280087		0,55 kg/pc

2. GUTTER OUTLET (gutter, round 150 mm, downpipe, round 100 mm)

CODE	DIMENSIONS	WEIGHTkg/unit
 RW ZSTDST 333100		0,65 kg/pc
 RW ZSTDO 333100		0,65 kg/pc
 RW ZSTDP 333100		0,65 kg/pc



Subject



NSR RAINWATER SYSTEM PARTS

Date	Rev.	Project no.	Dwg-no. NSR_RWS
Drawn by	Rev.date		
Scale	Project	Filename NSR_RWS.dwg	



⑩ — PIPE ELBOW





MATERIALS:

-  NORDIC STANDARD
-  NORDIC BROWN
-  NORDIC GREEN

1. PIPE ELBOW (downpipe, round 87 mm)

CODE	DIMENSIONS	WEIGHTkg/unit
 RW ZRBO 72087	d=87 mm, t=0,60 mm, 72 degr.	0,38 kg/pc
 RW ZRBOO 72087	d=87 mm, t=0,60 mm, 72 degr.	0,38 kg/pc
 RW ZRBOP 72087	d=87 mm, t=0,60 mm, 72 degr.	0,38 kg/pc

2. PIPE ELBOW (downpipe, round 100 mm)

CODE	DIMENSIONS	WEIGHTkg/unit
 RW ZRBO 72100	d=100 mm, t=0,60 mm, 72 degr.	0,46 kg/pc
 RW ZRBOO 72100	d=100 mm, t=0,60 mm, 72 degr.	0,46 kg/pc
 RW ZRBOP 72100	d=100 mm, t=0,60 mm, 72 degr.	0,46 kg/pc



Subject



NSR RAINWATER SYSTEM PARTS

Date	Rev.	Project no.	Dwg-no. NSR_RWS
Drawn by	Rev.date		
Scale	Project	Filename NSR_RWS.dwg	



①—OUTLET





MATERIALS:

-  NORDIC STANDARD
-  NORDIC BROWN
-  NORDIC GREEN

1. OUTLET (downpipe, round 87 mm)

CODE	DIMENSIONS	WEIGHTkg/unit
 RW ZRBOW 72087	d=87 mm, t=0,60 mm, 72 degr.	0,40 kg/pc
 RW ZRBOWO 72087	d=87 mm, t=0,60 mm, 72 degr.	0,40 kg/pc
 RW ZRBOWP 72087	d=87 mm, t=0,60 mm, 72 degr.	0,40 kg/pc

2. OUTLET (downpipe, round 100 mm)

CODE	DIMENSIONS	WEIGHTkg/unit
 RW ZRBOW 72100	d=100 mm, t=0,60 mm, 72 degr.	0,50 kg/pc
 RW ZRBOWO 72100	d=100 mm, t=0,60 mm, 72 degr.	0,50 kg/pc
 RW ZRBOWP 72100	d=100 mm, t=0,60 mm, 72 degr.	0,50 kg/pc



Subject



NSR RAINWATER SYSTEM PARTS

Date	Rev.	Project no.	Dwg-no. NSR_RWS
Drawn by	Rev.date		
Scale	Project	Filename NSR_RWS.dwg	



⑫ — FUNNEL





MATERIALS:

-  NORDIC STANDARD
-  NORDIC BROWN
-  NORDIC GREEN

1. OUTLET (downpipe, round 87 mm)

CODE	DIMENSIONS		WEIGHTkg/unit	
 RW ZRKEM 087	d=87 mm, t=0,60 mm		2,00 kg/pc	
 RW ZRKEMO 087	d=87 mm, t=0,60 mm		2,00 kg/pc	
 RW ZRKEMP 087	d=87 mm, t=0,60 mm		2,00 kg/pc	

2. OUTLET (downpipe, round 100 mm)

CODE	DIMENSIONS		WEIGHTkg/unit	
 RW ZRBKEM 100	d=100 mm, t=0,60 mm		2,10 kg/pc	
 RW ZRBKEMO 100	d=100 mm, t=0,60 mm		2,10 kg/pc	
 RW ZRBKEMP 100	d=100 mm, t=0,60 mm		2,10 kg/pc	



Subject



NSR RAINWATER SYSTEM PARTS

Date	Rev.	Project no.	Dwg-no. NSR_RWS
Drawn by	Rev.date		
Scale	Project	Filename NSR_RWS.dwg	



⑫ FUNNEL





MATERIALS:

-  NORDIC STANDARD
-  NORDIC BROWN
-  NORDIC GREEN

1. OUTLET (downpipe, round 87 mm)

CODE	DIMENSIONS	WEIGHTkg/unit
 RW ZRKEL 087	d=87 mm, t=0,60 mm	1,20 kg/pc
 RW ZRKELO 087	d=87 mm, t=0,60 mm	1,20 kg/pc
 RW ZRKELP 087	d=87 mm, t=0,60 mm	1,20 kg/pc

2. OUTLET (downpipe, round 100 mm)

CODE	DIMENSIONS	WEIGHTkg/unit
 RW ZRKEL 100	d=100 mm, t=0,60 mm	1,30 kg/pc
 RW ZRKELO 100	d=100 mm, t=0,60 mm	1,30 kg/pc
 RW ZRKELP 100	d=100 mm, t=0,60 mm	1,30 kg/pc